

# FUGU<sup>®</sup>

USER **GUIDE**

INFLATABLE CHAIR



**FUGU**<sup>®</sup>'s advice :

**Inflate the furniture  
to 30%. Then add the  
customised cover and  
inflate fully.**

# FUGU<sup>®</sup> VALVE

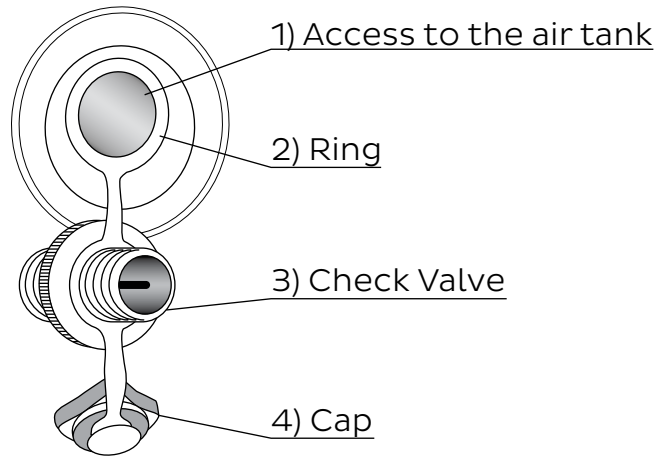

Inflate the furniture at 60% with the **access to the air tank**. Then reajust the cover easily.

Close the **check valve** and finish inflation.

Screw the **cap**.

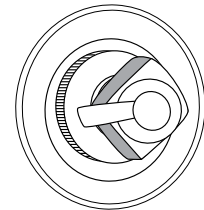
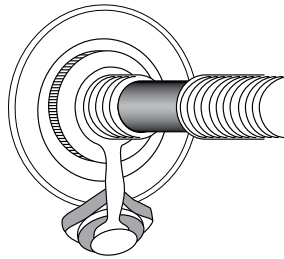
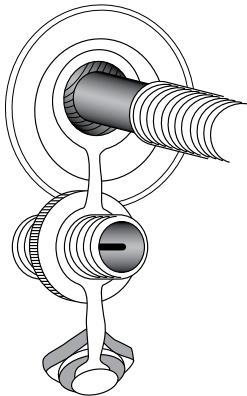

## LIGHTING OPTION

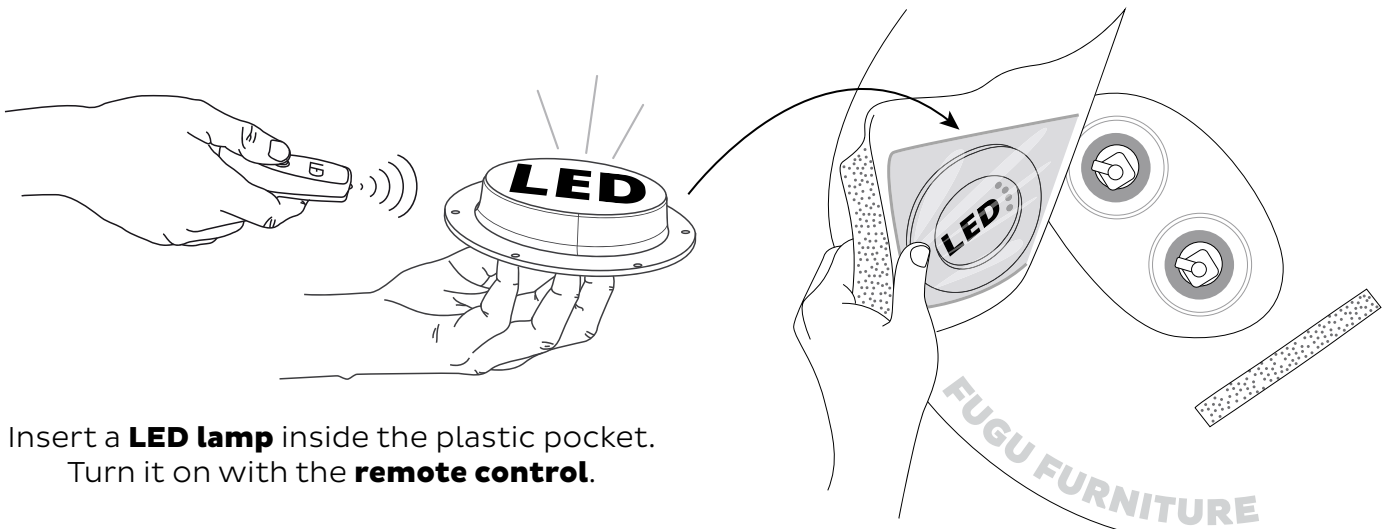

Insert a **LED lamp** inside the plastic pocket.  
Turn it on with the **remote control**.



01733 511030  
sales@xldisplays.co.uk  
www.xldisplays.co.uk

# FUGU INFLATABLE CHAIR

**1)** See the location of the valve.

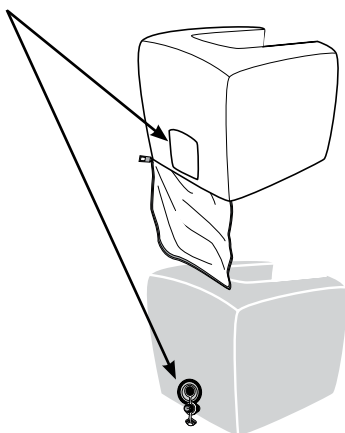

**2)** Lay down the chair and its cover on the floor, inflate partially then.

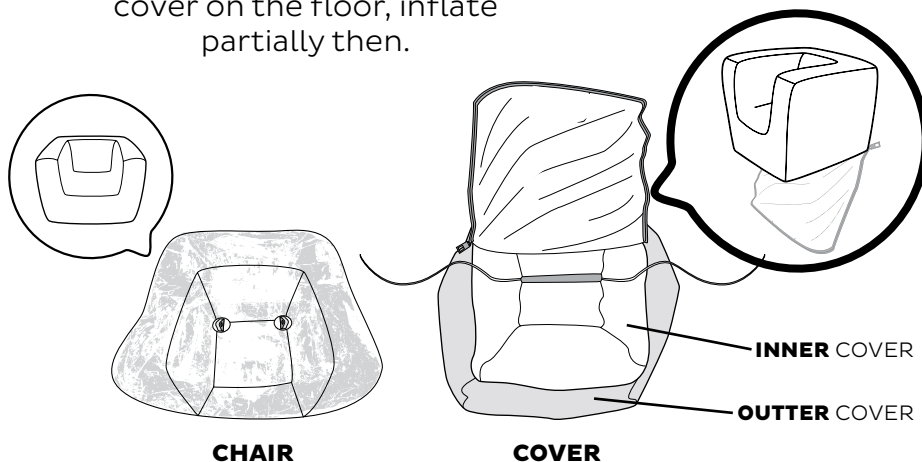

**3)** Place the plastic bladder as the drawing below.

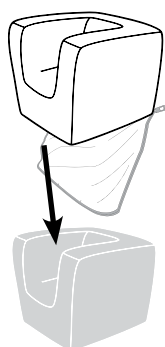

**4)** Put the cover string in the eyelets of the structure.

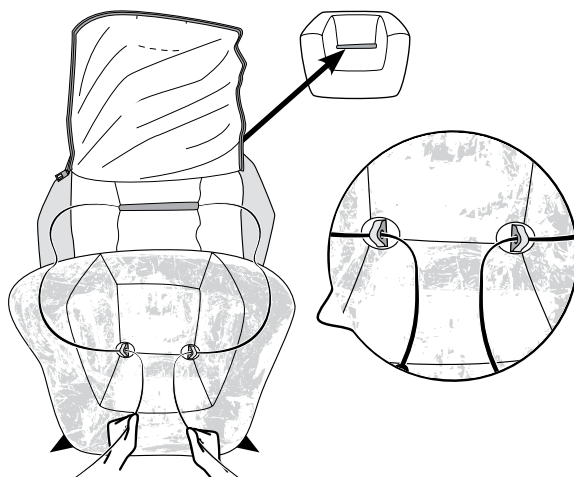

**5)** Tighten strong and make a knot.



**5)** Finish covering the plastic bladder.

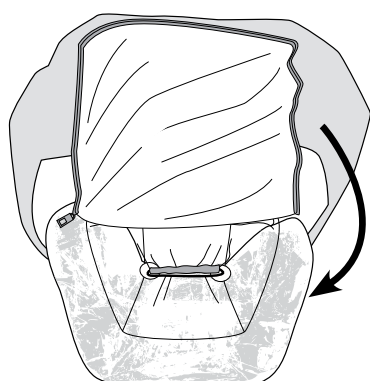

**5)** Place the cover properly.

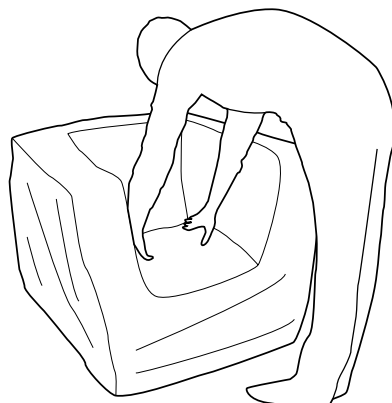

**6)** Close the check valve and finish inflating.

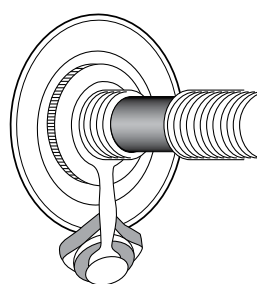

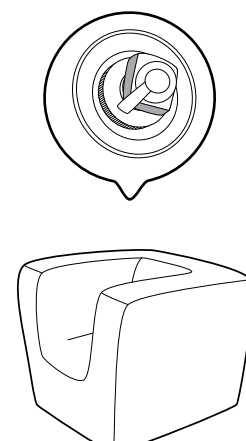

**7)** Screw the cap.

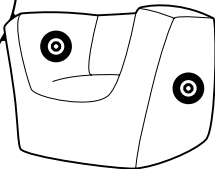
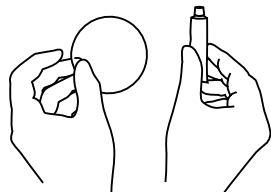
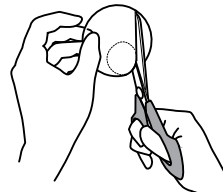
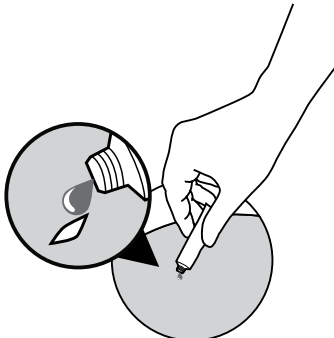
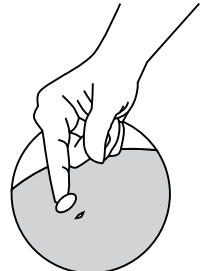
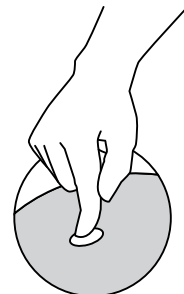

# REPAIRS

The fugu furniture has to be inflated to making repairs.  
Holes bigger than 2cm cannot be repaired.

<p><b>IF THERE IS A HOLE</b></p> 	<p><b>1) Inflate the chair.</b></p>	<p><b>2) Take the glue and the plastic patch out of the plastic bag.</b></p> 	<p><b>3) Cut out a circle that is twice the size of the hole.</b></p> 
<p><b>4) Carefully apply some glue on the hole.</b></p> 	<p><b>5) Immediately place the patch over the hole.</b></p> 	<p><b>6) Press the patch for a few minutes</b></p> 	<p><b>7) Remove all air bubbles and glue residue around the patch.</b></p> 

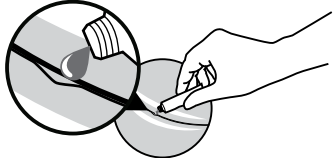
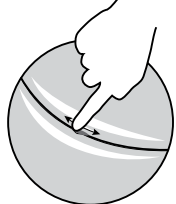
<p><b>IF THERE IS A HOLE AT THE JOINT</b></p> 	<p><b>1) Inflate the chair.</b></p>	<p><b>2) Take the glue out of the plastic bag.</b></p> 	<p><b>3) Carefully apply some glue on the hole.</b></p> 
<p><b>4) Gently spread the glue before it dries (30 seconds).</b></p> 	<p><b>5) Do not use too much glue to avoid ugly residue.</b></p> 		



**Do not use the Airflower for 48 hours after any repairs.**