



PARTS (NOT TO SCALE)

Ground Stakes (x6)



Wire rope setting-out guide (x1)



Ground Stake Puller (x1)

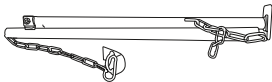

Base Support and Ground Spike (x1)

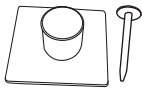

Poles (x5)

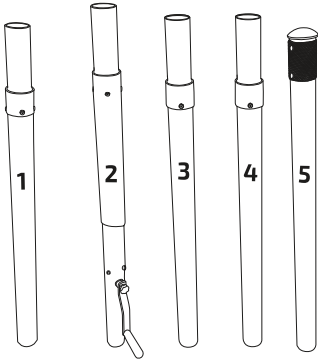

TOOLS REQUIRED



FOR ATTENTION

IMPORTANT NOTE:
PAY ATTENTION TO WIND
DIRECTION WHEN
ASSEMBLING/DISASSEMBLING

1

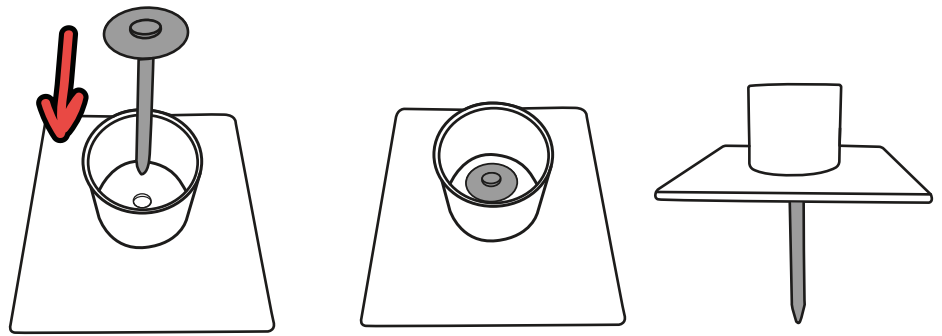

Ensuring the ground the tent is to be pitched on is soft - use the base pole support to mark out where the centre of the tent will be.

2

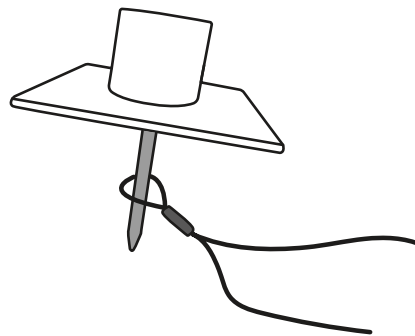

Slide the looped section of the wire setting rope underneath the central stake of the base pole support and temporarily secure it into the ground

3

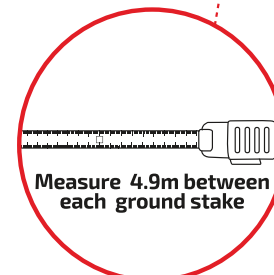
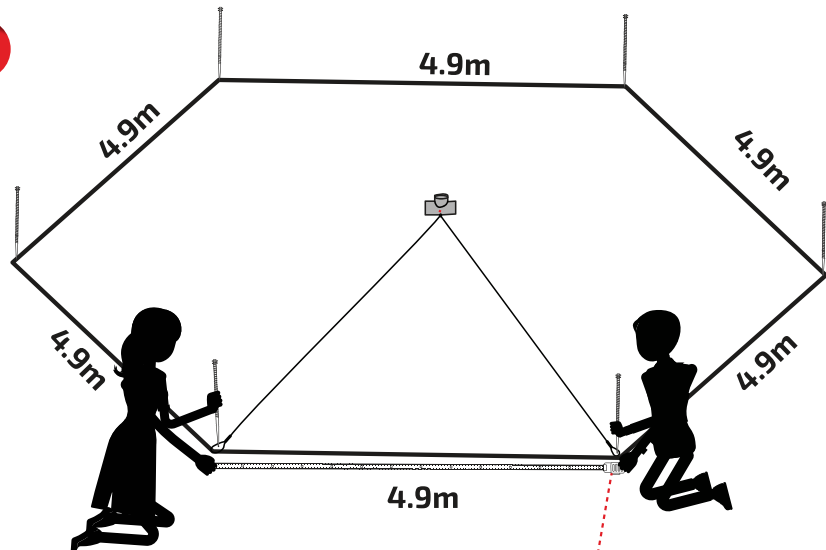

Measure 4.9m between each ground stake

B

Extend the wire setting rope to full length and separate the two sections of the rope. Use the first section of rope to mark out your first point and take the second section of the wire setting rope and measure 4.9m across from your first point to find the second point of the tent.

4

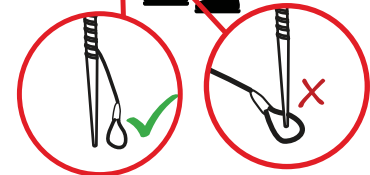
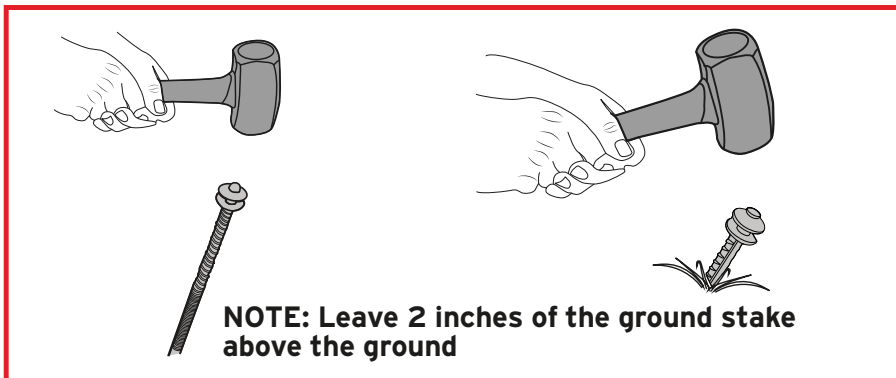
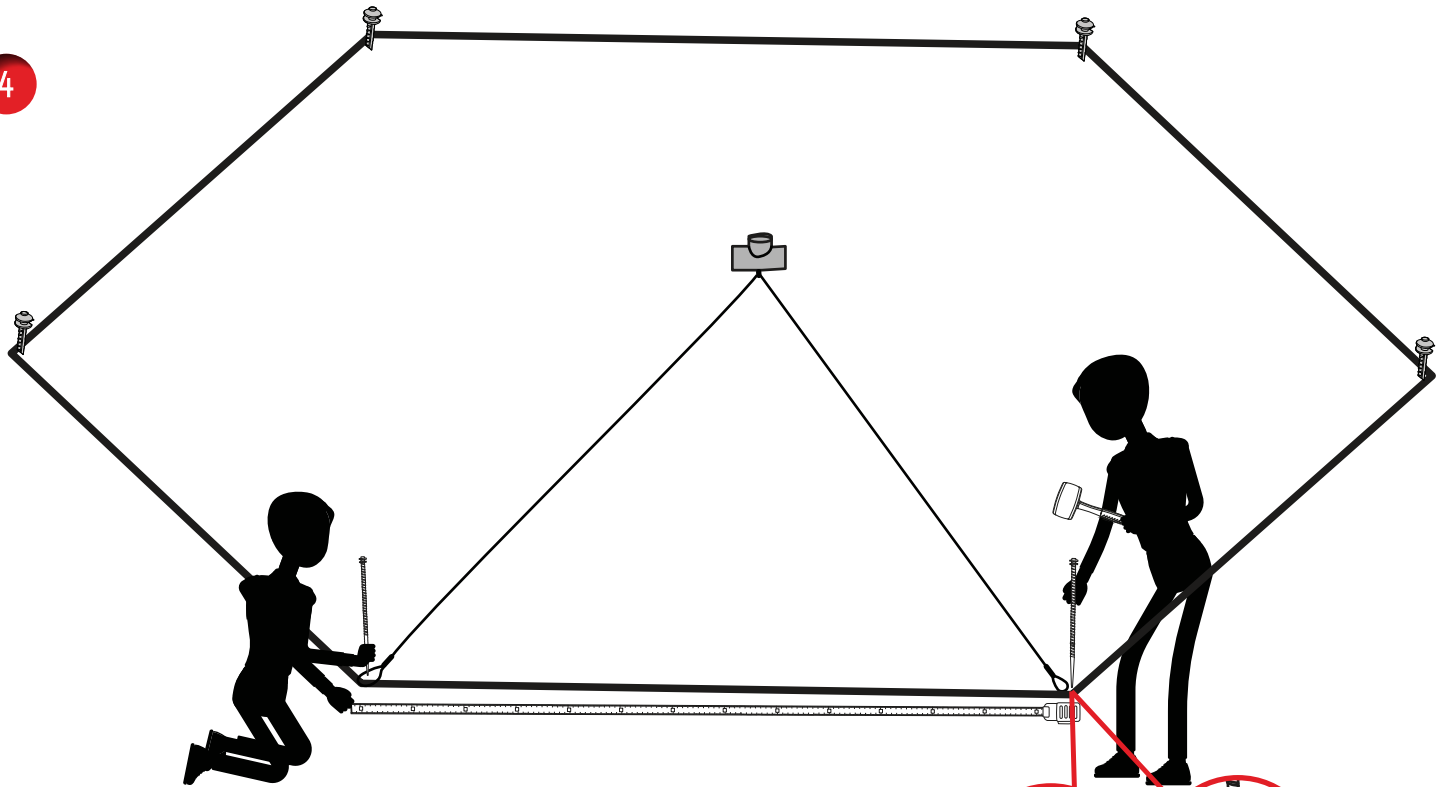

NOTE: Remove ground stake from rope before hammering

Use a mallet to secure one of the ultra-strong ground stakes into the turf where your two points are marked out, taking care to leave two inches of the stake visible above the ground. Make sure the wire setting rope is loose and is not trapped under or attached to the ground stakes. Repeat steps three and four until you have six points.

5

When you're done, pull the central base pole support out of the ground and remove the wire setting rope from underneath. Then, use a mallet to properly secure the base pole support into the ground.

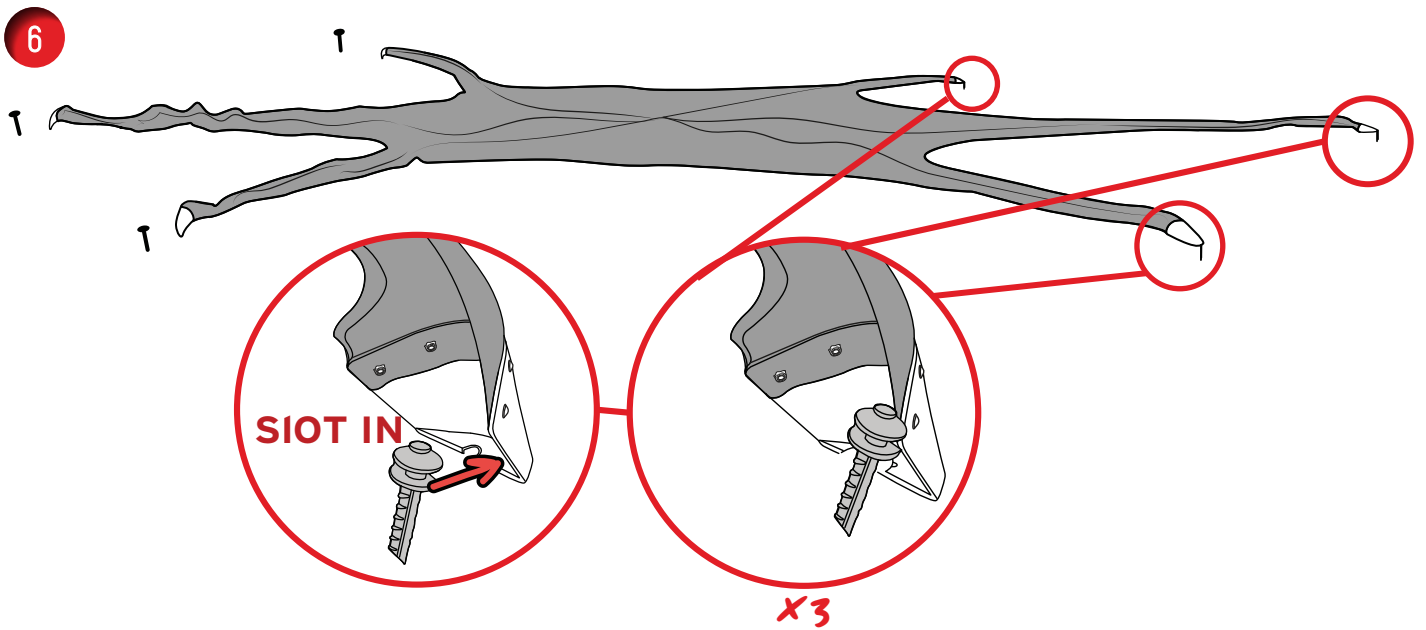

Lay out the canopy of the tent and slot three of the metal horseshoe ends of the graphic around the ground stakes, ensuring the centre of the graphic is draped over the central base support and three of the graphic legs are still free.

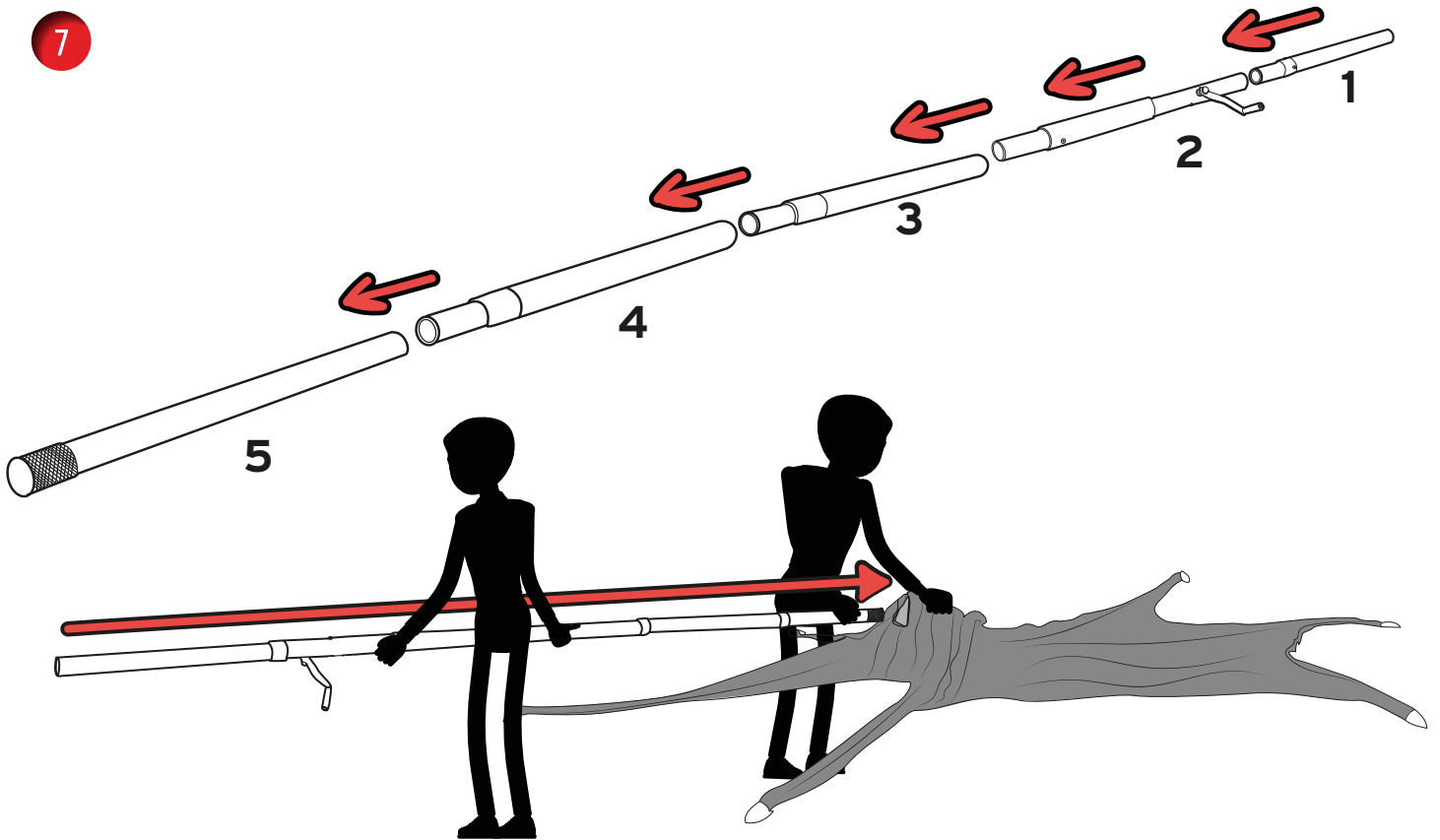

NOTE: The end of pole 5 fits into the top of the canopy

Next, slot the numbered sections of the central pole support together and slide the pole horizontally underneath the graphic, making sure the end of the pole (part five) is level with the centre of the canopy.

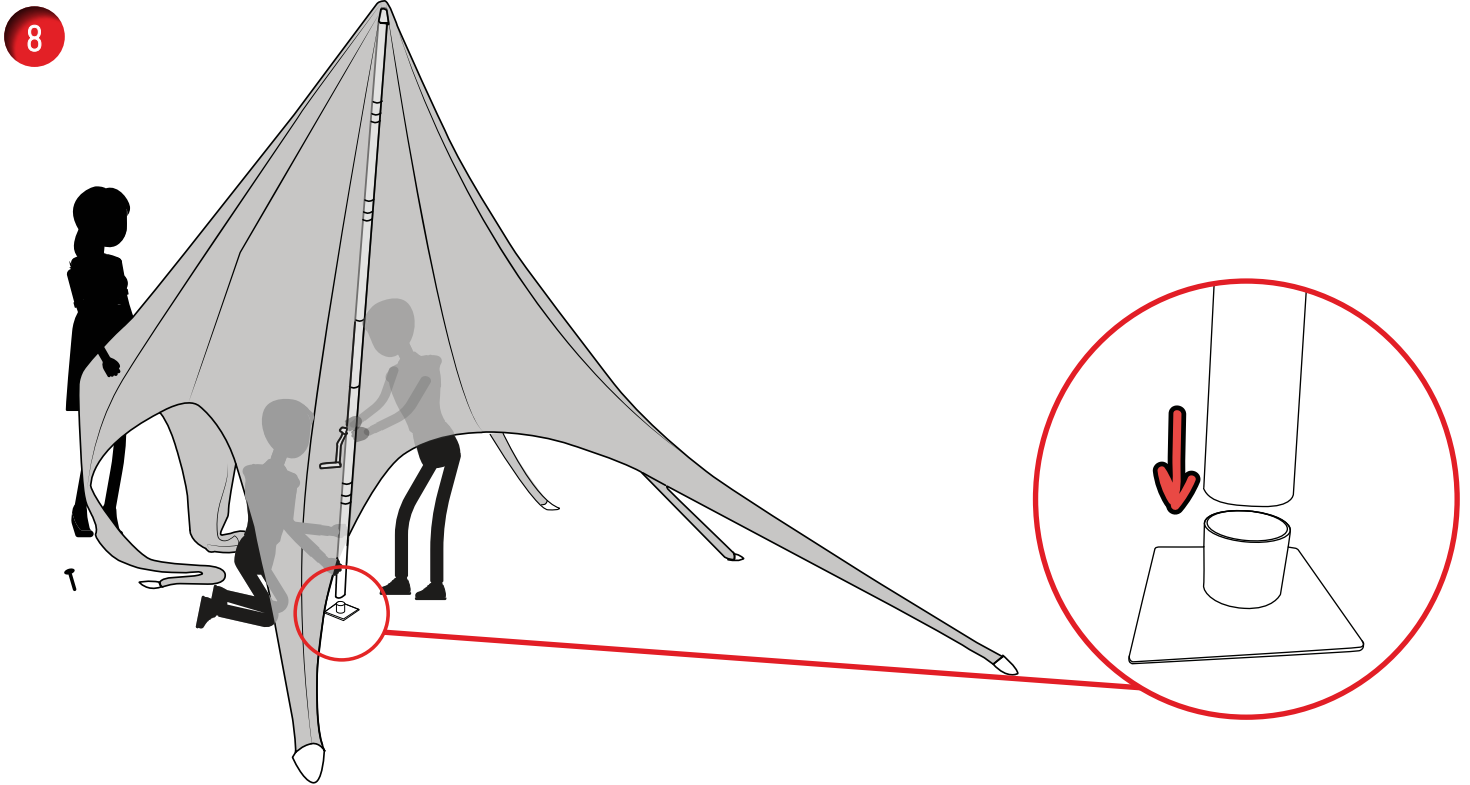

Begin to move the pole into a vertical position until it is straight and the bottom of the pole (part one) can be firmly slotted into the central pole support base.

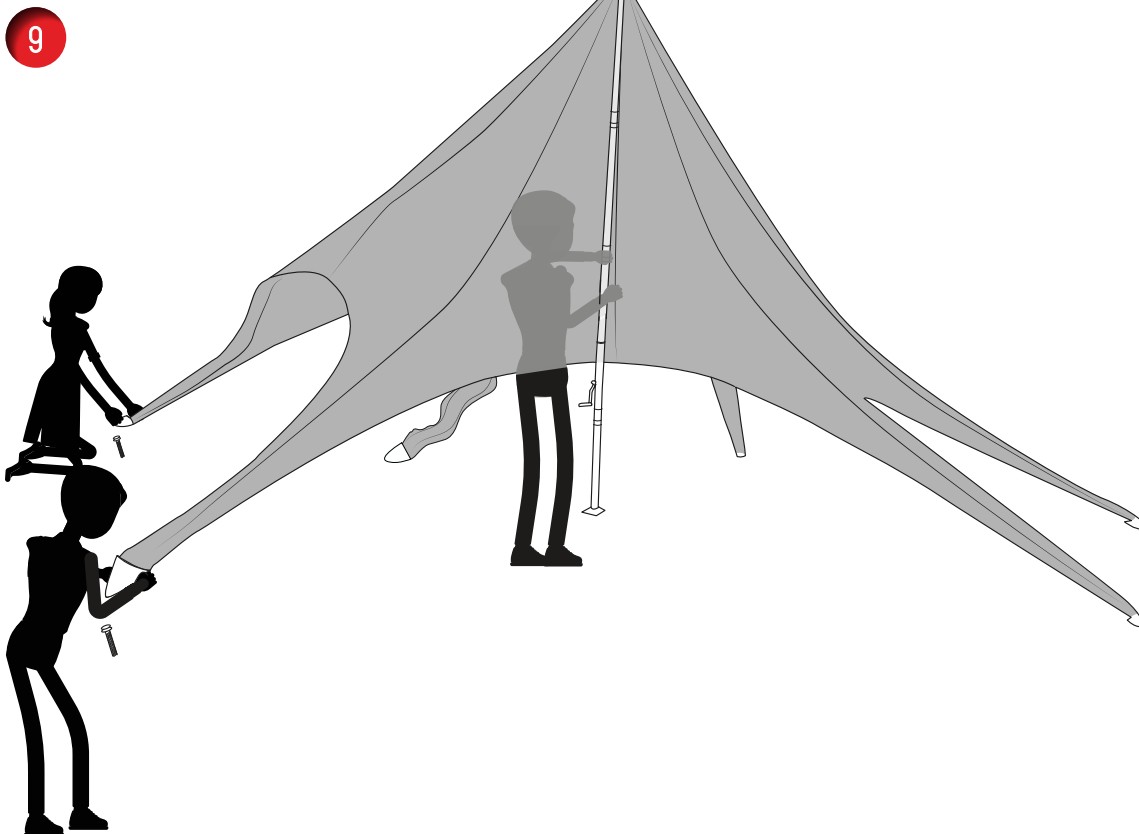

At this stage you can attach the remaining two horseshoe sections of the canopy to the last two ground stakes.

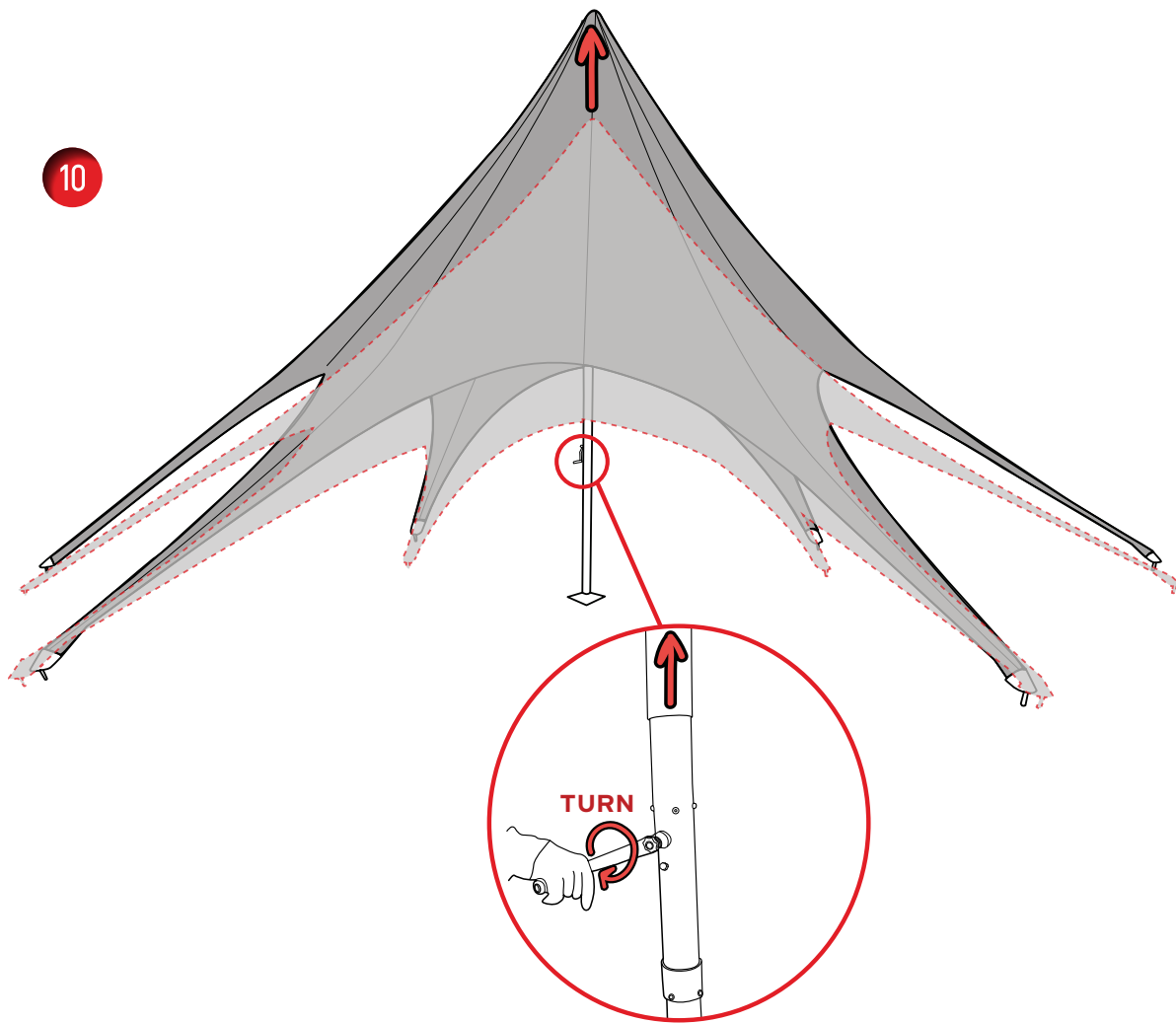

To tension the graphic, turn the crank on the central pole support and, once complete, remove the crank handle.

DISASSEMBLY

1

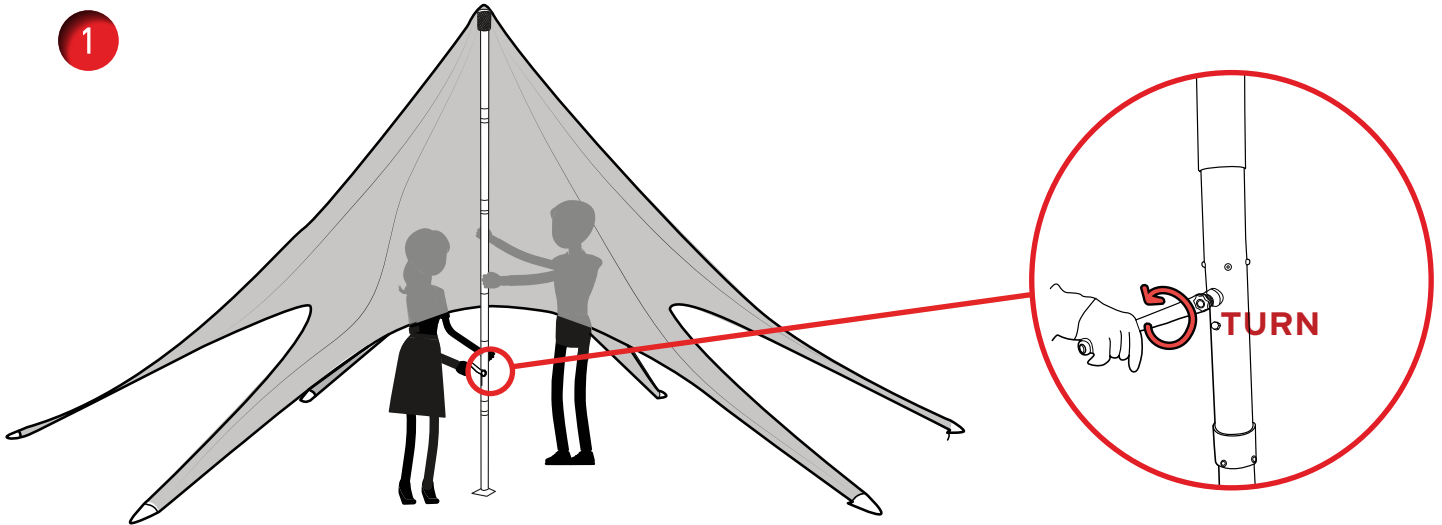

2

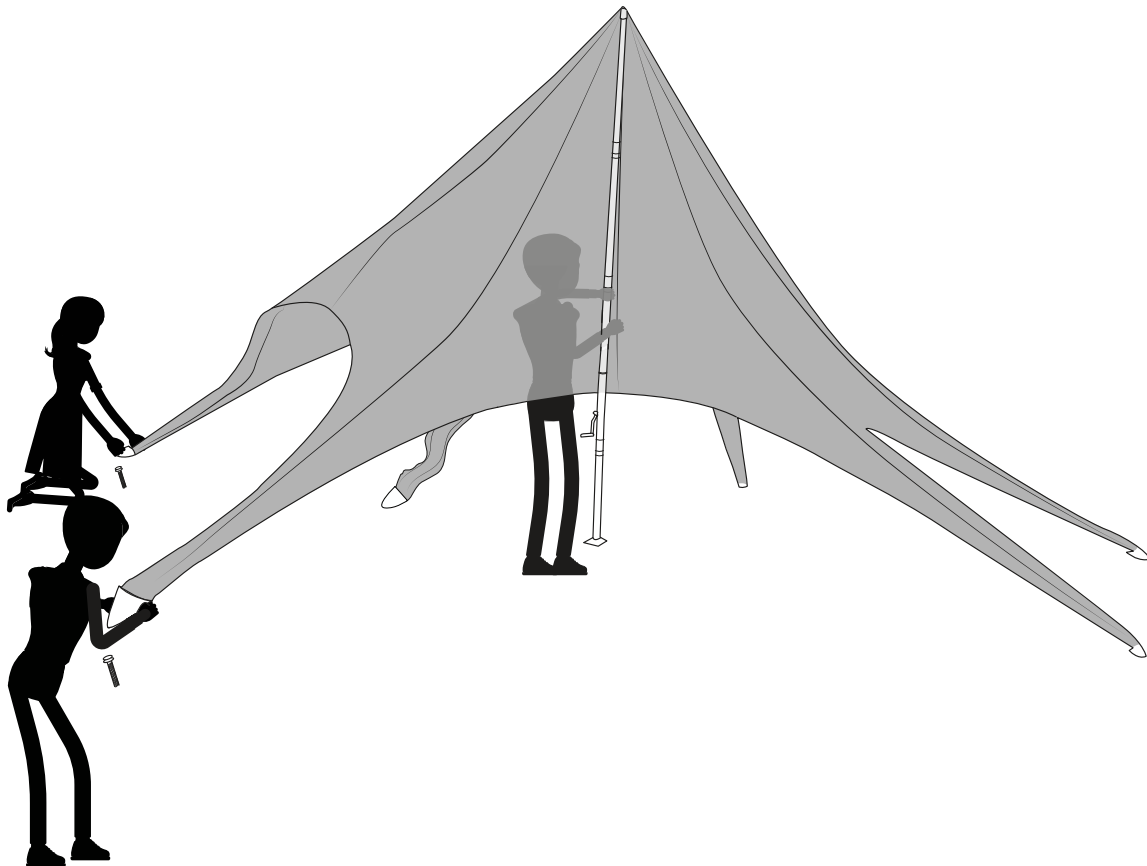

DISASSEMBLY

