



Mercury is a stylish workstation or greeting counter constructed from MDF with high quality finish thermoformed laminated tops.

### features & benefits

- Constructed from composite materials and flexible MDF tambour
- Flat packed, easy to transport and quick to assemble
- Allen key supplied
- Load bearing up to 75kgs
- Tops are available in Birch, Black, Silver or White thermoformed finishes
- Choice of Luxury Foam Backed Loop Nylon fabric wrap colours
- Open or closed back available
- Cable management port included



**Closed back** - fabric, aluminium or beech tambour

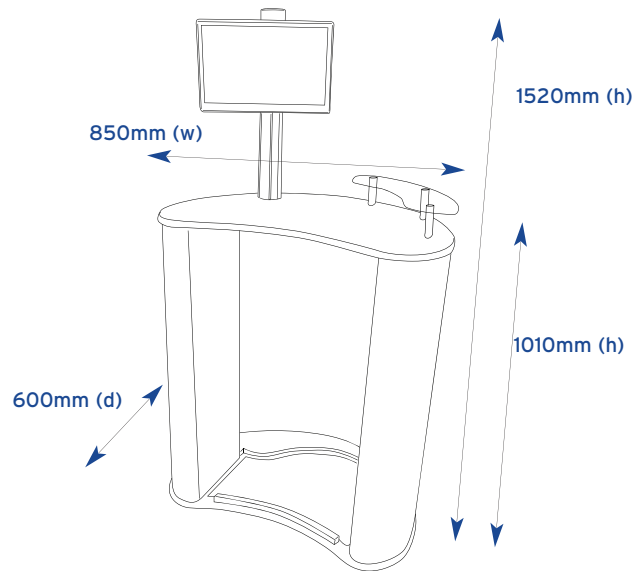

### hardware specifications

**Overall size (h) x (w) x (d):**  
1520mm (top of LCD post)  
x 850mm x 600mm

**Weight:**  
19kg

**Optional internal shelf size:**  
180mm Deep

### wrap specifications

**Tambour Wrap dimensions (h) x (w):**  
970mm x 2320mm

If applying a graphic to the wrap, an allowance should be made to its size to accommodate material type, thickness etc.

## Mercury assembly

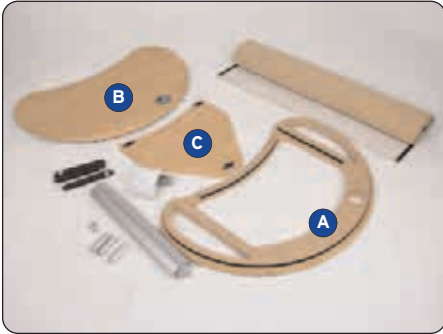

Pro Kit includes: Base (A), top (B), internal shelf (C), 3 x Twist & Lock posts, wrap, Linear post, monitor bracket, acrylic top shelf x stand-offs, 3 x screws, fixings, 2 x Allen keys



1 Place the base on the floor and feed the wrap around the hook and loop mounted area.



2 Take the top and lower onto the wrap, inserting the hook and loop mount into the wrap securely



3 Take the internal shelf and twist in the 3 Twist & Lock posts in the slots provided.



4 Lift the shelf into the unit and twist in each post to secure the shelf

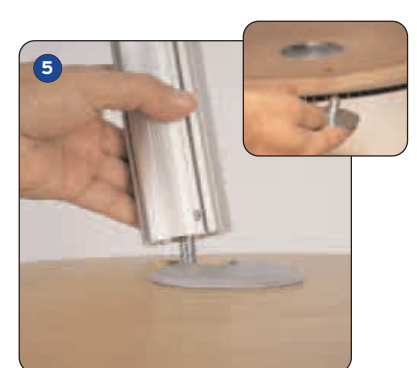

5 Fasten the linear post to the top with the screw and washer



6 Take the monitor bracket and screw loosely into the linear slider

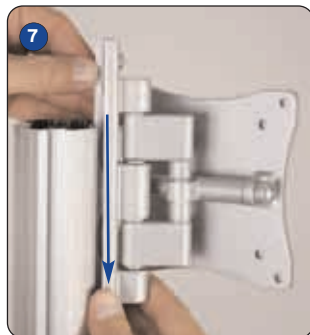

7 Slide the assembled bracket down the post into position and tighten screws to secure.

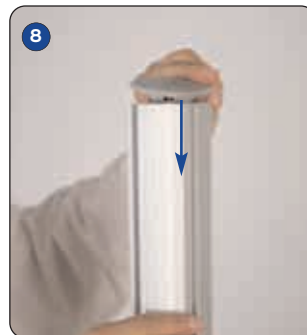

8 Complete unit by attaching Linear post top and cable management port into place.

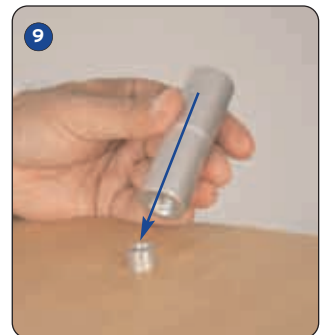

9 Take each stand-off and screw onto the top of each fixing supplied.

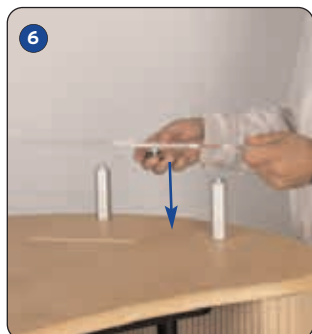

6 Lower the acrylic shelf onto the top of the 3 stand-offs.



7 Secure into position by screwing in the tops of each stand-off

NB - For the standard unit without an internal shelf miss out steps 3 and 4.

