

1

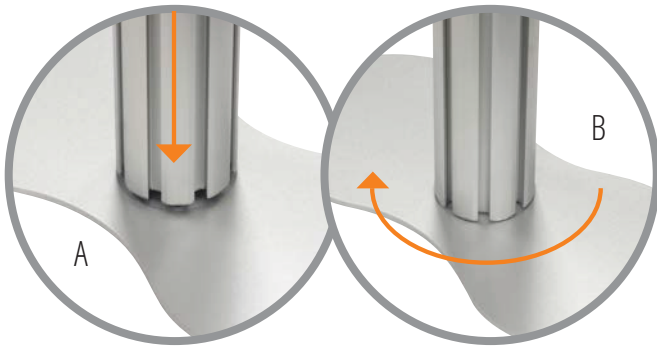

Place base plate on the floor, position lower post centrally over male fitting of base plate (A), and rotate until assembly drops into position, continue rotating clockwise through 90° to secure (B).



2



Affix upper post to lower post by positioning female end centrally over male fitting (C), and rotate until assembly drops into position, continue rotating clockwise through 90° to secure (D).

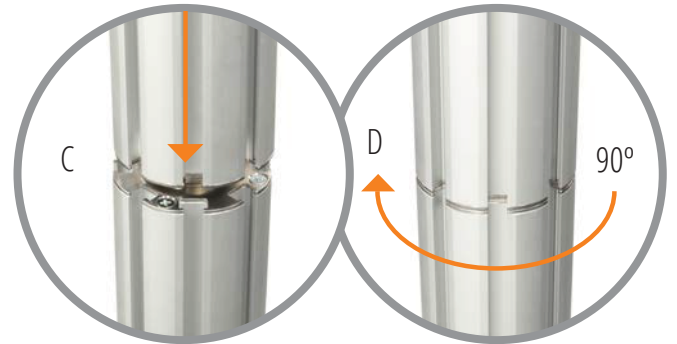

3

Repeat for remaining base and posts to complete assembly of uprights.

4.1

Assemble 750mm horizontal (H2) profiles by slotting and twisting together to join.

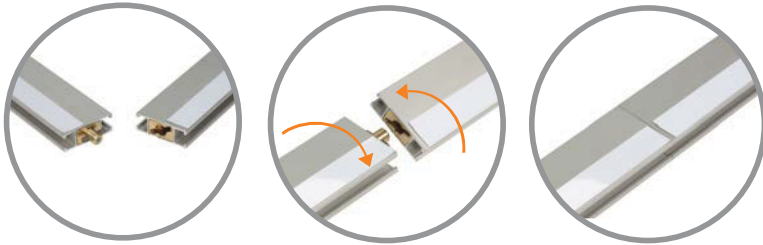

4.2



Carefully rest thumb screw feet on floor and adjust to level if necessary.

4.3

Slot T-Loc clamps of 1500mm (H2) profile into post channel and close T-Loc levers to secure.



5



Ensuring the single steel strip of first vertical (V) rail is adjacent to post, slot T-Loc clamp of assembled profile into channel of horizontal (H2) at corner. Close bottom T-Loc lever to secure and repeat for opposite vertical rail.

6

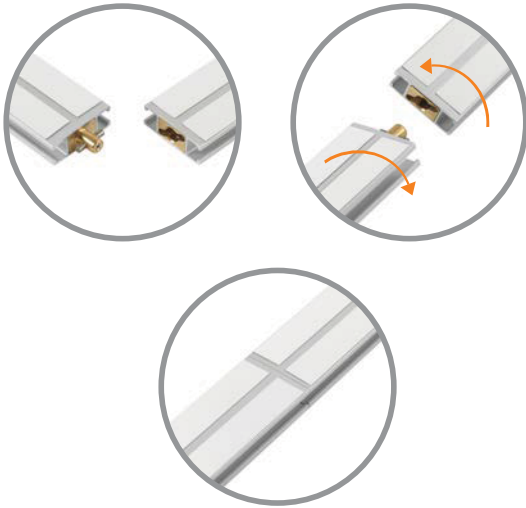

Assemble supporting 750mm horizontal profiles (V1) by slotting and twisting together to join.

Please note these profiles have double steel strip.

7



Insert T-Loc clamp into channel and line up with joining line of (H2) profiles. Close bottom T-Loc lever to secure.

8

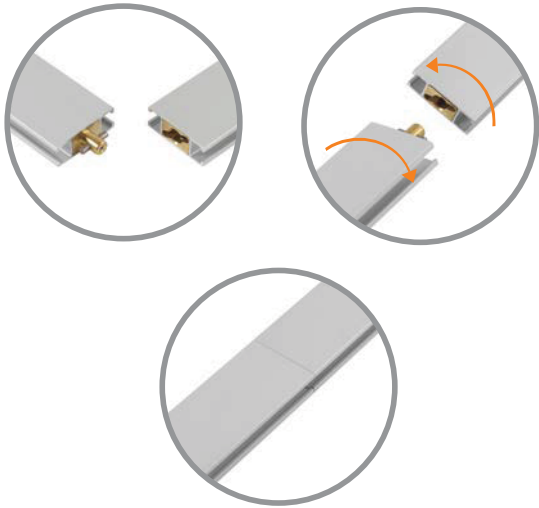

Assemble second 750mm horizontal (H) profiles by slotting and twisting together to join.

9



Connect second 1500mm horizontal (H) using the T-Loc clamps, to top of assembled verticals (V, V and V1) Close T-Loc levers on vertical rails to secure, then close T-Loc levers on horizontal (H)

10.1



Ensuring the single steel strip of 355 vertical (V2) rail is adjacent to post, slot T-Loc clamp into channel of horizontal (H) at corner. Close bottom T-Loc lever to secure and repeat for opposite vertical rail.

10.2



Take final 355mm (V2) profile. Insert T-Loc clamp into channel and line up with joining line of (H) profiles. Close bottom T-Loc lever to secure.

Please note this profile has a double steel strip.

11

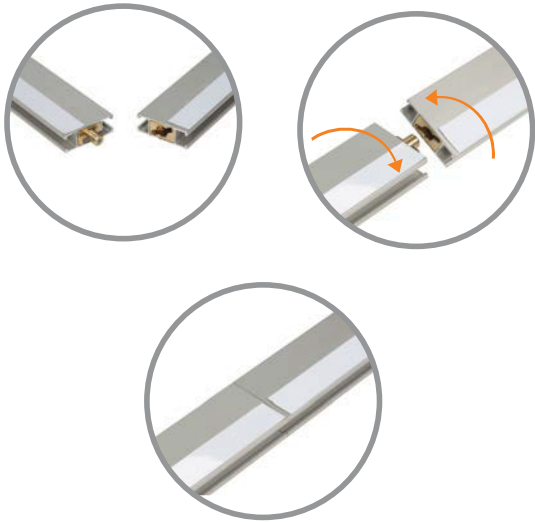

Assemble final 750mm horizontal (H1) profiles by slotting and twisting together to join

11.1



Ensuring steel strip is uppermost, slot 1500mm profile onto top of vertical rails (V2, V2 & V2) and channel of posts. Close remaining T-Loc levers to finish assembly of the framework.

12



Starting from the top left-hand side of the system, unroll the first graphic panel and align the magnetic tape with steel fixing strips of the framework. Work across the frame, taking care not to crease the panel. Repeat for remaining graphic panel.

13.1



Remove one screw + spacer set from 100mm connector bar on LED/LCD mounting bracket, put aside then loosen other 3 screws slightly.

13.2

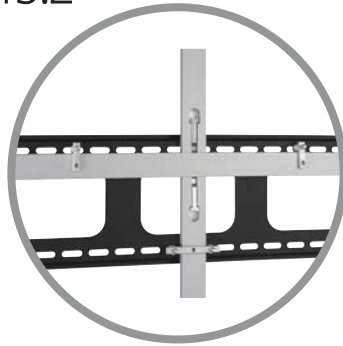

Carefully hook smaller 500mm connector bars over horizontals (H) ensuring they are flush against the profile and straight.

13.3



Adjust 100mm profile by pushing into vertical position, over vertical profile (V1)

13.4

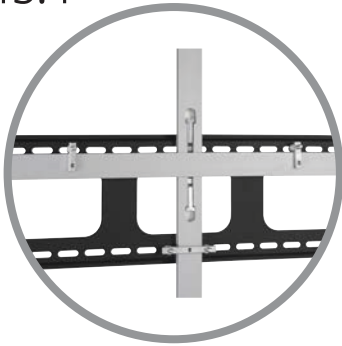

Remove spacer from discarded screw and spacer set, place spacer between connector bar and profile, then insert screw all the way through and tighten to secure.

13.5



Ensure all 4 screws are tight using a screwdriver n.b hold the connector bar in position to prevent it from repositioning while tightening.

13.6

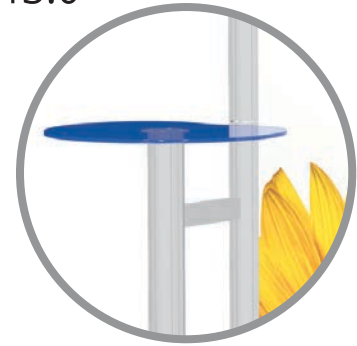

Add podium table supplied to left or right post.

14



With the elongated holes on the mounting arms lowermost, align arms centrally with 4 off fixing points on rear of screen equidistant from the top. Insert 4 off screws with suitable washers and tighten.

15



Position screen centrally above bracket and lower until top of both mounting arms hook over mount.



16.1



16.2



Slide locking bar between the mounting arms and the plasma mounting bracket if desired. For extra security, there is a facility to add a padlock to the locking bar.

17

Display is now complete



