



Centro Multimedia Kits 1, 3 and 4 Assembly Instructions

www.xldisplays.co.uk

01733 511 030



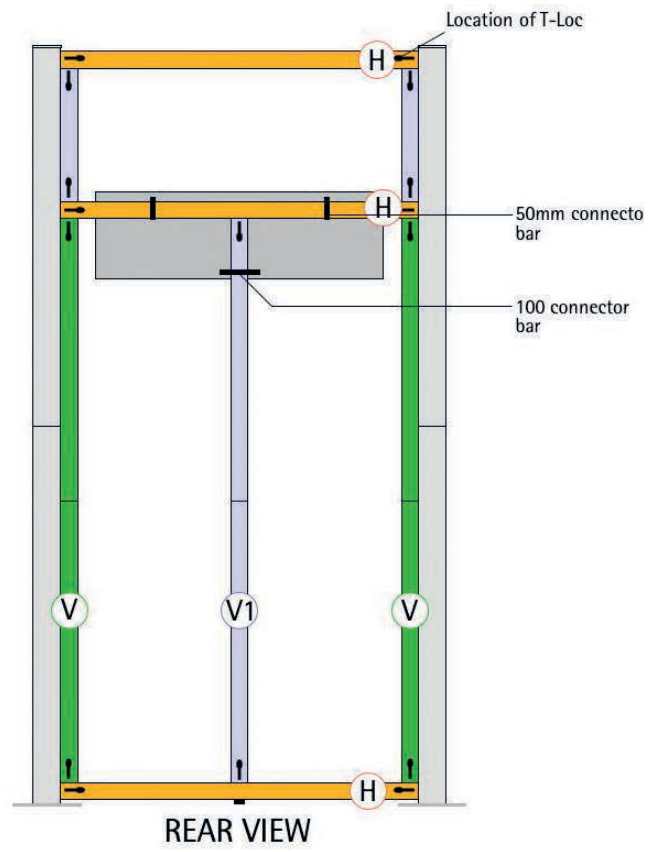
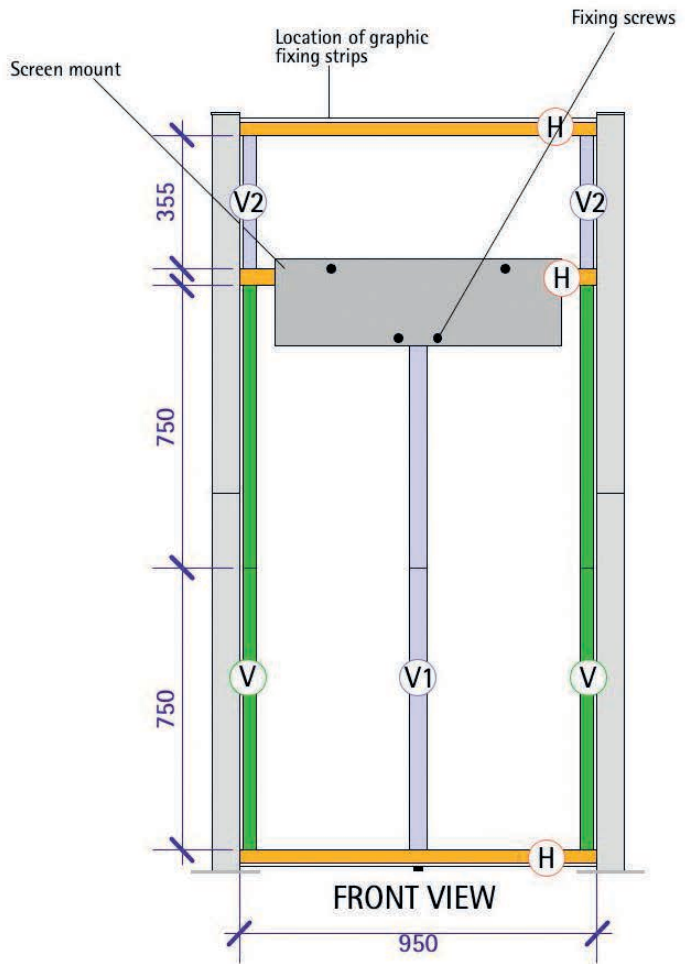

1



Place base plate on the floor, position lower post centrally over male fitting of base plate (A), and rotate until assembly drops into position, continue rotating clockwise through 90° to secure (B).

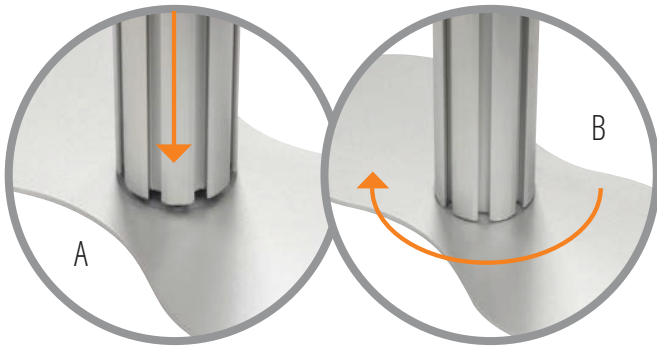

2



Affix upper post to lower post by positioning female end centrally over male fitting (C), and rotate until assembly drops into position, continue rotating clockwise through 90° to secure (D).

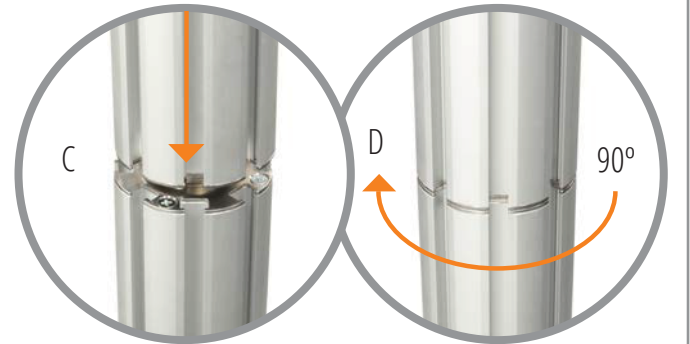

3

Repeat for remaining base and posts to complete assembly of uprights.

4.1



Affix 950mm horizontal (H) profile to post by carefully resting thumb screw foot on floor and adjust to level if necessary.

4.2



Slot T-Loc clamps of 950mm profile into post channel and close T-Loc levers secure.

5.1

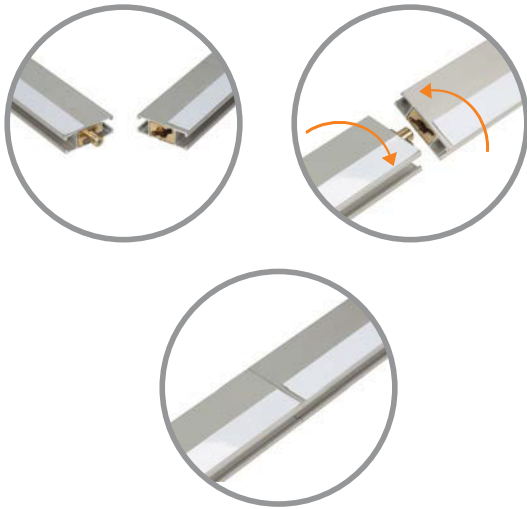

Assemble 750mm vertical (V1) profiles by slotting and twisting together to join.

5.2



Ensuring the single steel strip of first vertical (V) rail is adjacent to post, slot T-Loc clamp of assembled profile into channel of horizontal (H) at the corner. Close bottom T-Loc lever to secure and repeat for opposite vertical rail.

6.1

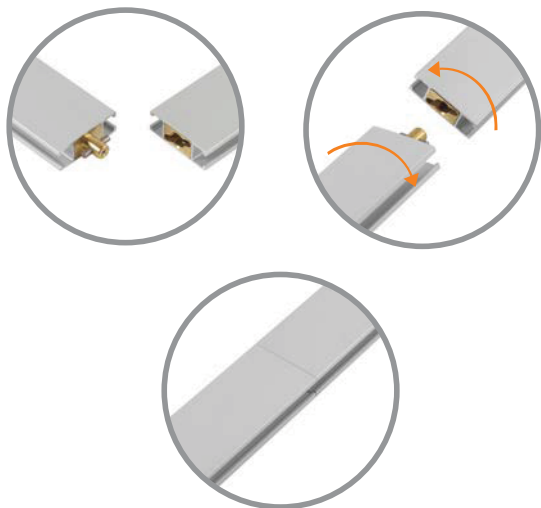

Assemble supporting 750mm horizontal profiles (V1) by slotting and twisting together to join.

Please note these profiles have no steel strip.

6.2



Insert T-Loc clamps into channel and line up with thumb screw foot. Close bottom T-Loc lever to secure.

7



Connect second 950mm horizontal (H), using the T-Loc clamps, to top of assembled verticals (V, V and V1) Close T-Loc levers on vertical rails to secure, then close T-Loc levers on horizontal (H)

8



Ensuring the single steel strip of 355mm vertical (V2) rail is adjacent to post, slot T-Loc clamp into channel of horizontal (H) at corner. Close bottom T-Loc lever secure and repeat for opposite vertical rail.

9



Link final 950mm horizontal profile (H) and with steel strip uppermost, slot onto top of vertical rails (V2 and V2) and channel of posts. Close remaining T-Loc levers to finish assembly of the framework.

10



Starting from the top left-hand side of the system, unroll the first graphic panel and align the magnetic tape with steel fixing strips of the framework. Work across the frame, taking care not to crease the panel. Repeat for remaining graphic panel.



11.1



Remove one screw + spacer set from 100mm connector bar on LED/LCD mounting bracket, put aside then loosen other 3 screws slightly.

11.2



Carefully hook smaller 50mm connector bars over horizontals (H) ensuring they are flush against the profile and straight. The bracket should be central between the posts.

11.3



Adjust 100mm profile by pushing into vertical position, over vertical profile (V1)

11.4

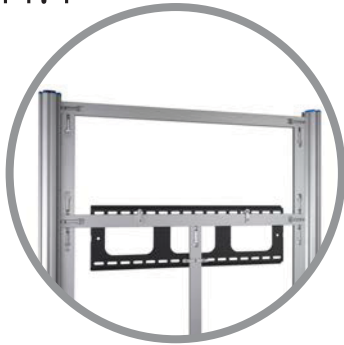

Remove spacer from discarded screw and spacer set, place spacer between connector bar and profile, then insert screw all the way through and tighten to secure.

11.5



Ensure all 4 screws are tight using a screwdriver n.b hold the connector bar in position to prevent it from repositioning while tightening.

11.6

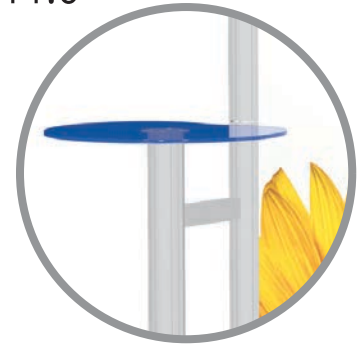

If applicable, add podium table supplied to left or right post.

12



With the elongated holes on the mounting arms lowermost, align arms centrally with 4 off fixing points on rear of screen equidistant from the top. Insert 4 off screws with suitable washers and tighten.

13



Position screen centrally above bracket and lower until top of both mounting arms hook over mount.



14.1



14.2



Slide locking bar between the mounting arms and the screen mounting bracket if desired. For extra security, there is a facility to add a padlock to the locking bar.

20

To complete Centro multimedia kits, please affix additional panels relevant to the kit ordered.





